

### Features

- 33" (838.2 mm) minimum base cabinet width for top-mount installation.
- 36" (914.4 mm) minimum base cabinet width for undermount installation.
- Single bowl.
- 9" (229 mm) depth provides generous workspace.

### Material

- KOHLER® enameled cast iron.

### Installation

- Top-mount or undermount.

### Recommended Products/Accessories

- K-8801 Sink drain and strainer with tailpiece
- K-8799 Sink drain and strainer basket
- K-23726 Drain treatment
- K-23725 Cast iron cleaner
- 1411886 Undermount sink kit 23"

### Optional Products/Accessories

- K-8342 Sink rack for Iron/Tones® kitchen sink
- K-11352 Disposal Flange with Stopper
- K-9000 P-Trap



### Codes/Standards















ASME A112.19.1/CSA B45.2

### KOHLER® Enameled Cast Iron Kitchen Sink Lifetime Limited Warranty

See website for detailed warranty information.

### Available Colors/Finishes

*Color tiles intended for reference only.*

Color	Code	Description
	0	White
	FF	Sea Salt™
	96	Biscuit
	NY	Dune
	95	Ice™ Grey
	G9	Sandbar
	K4	Cashmere
	FT	Basalt
	58	Thunder™ Grey
	FP	Caviar
	7	Black Black™
	GRL	Grey Lavender
	DGB	Indigo Blue
	PLM	Black Plum

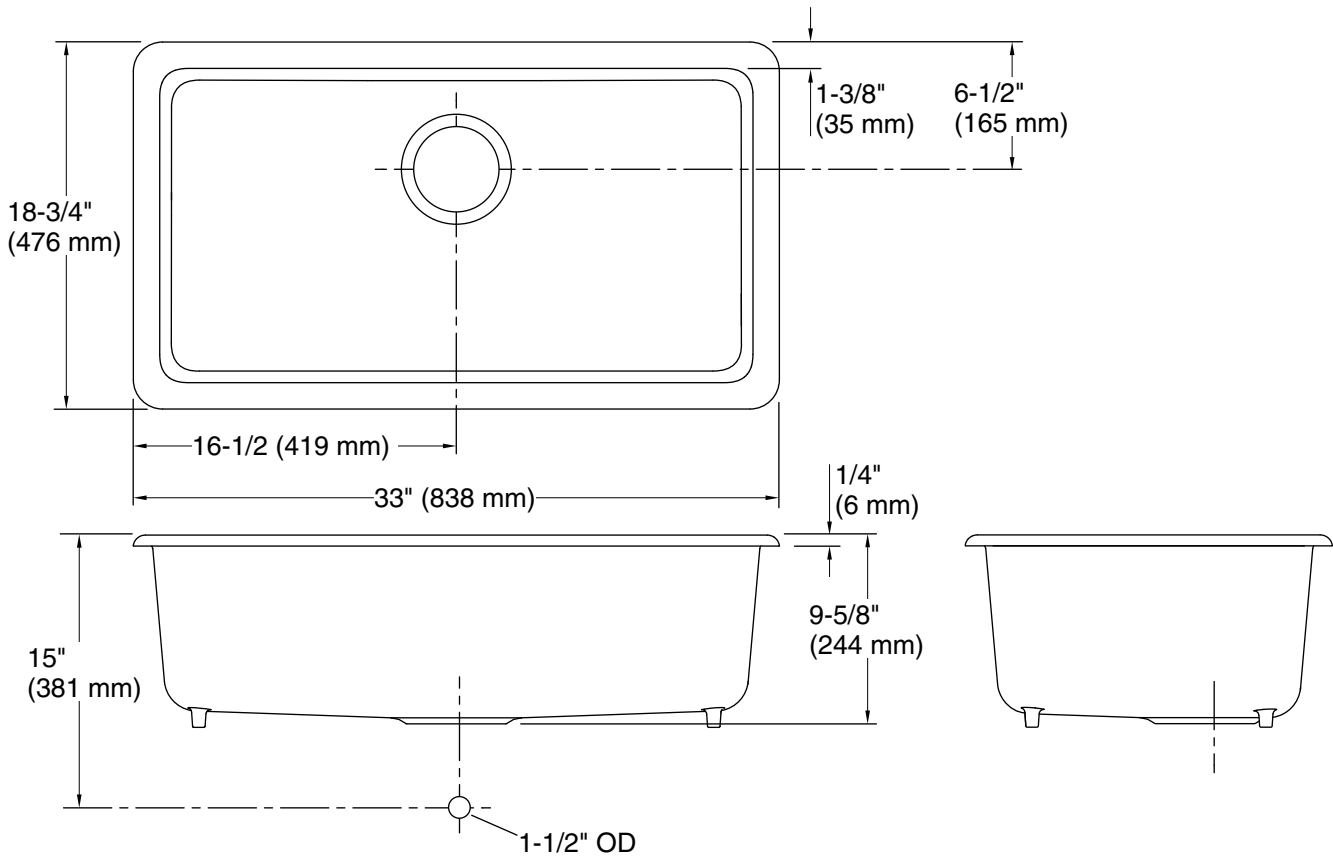

### Technical Information

All product dimensions are nominal.

Installation:	Undermount, Top-mount
Min. base cabinet width:	36" (914 mm)
Bowl area (Only):	Length: 30-5/16" (770 mm) Width: 16-1/16" (408 mm) Bowl depth: 9" (229 mm) Water depth: 9" (229 mm)
Drain hole:	3-7/8" (98 mm)
Template:	1043168-7, required, included

### Notes

Install this product according to the installation instructions.

Countertop manufacturer or cutter must use the cut-out template provided with the product, or a current one provided by Kohler Co. (call 1-800-43-FOCUS). Kohler Co. is not responsible for cut-out errors when the incorrect cut-out template is used.