

Features

- Geometric oval basin with vertical sides.
- Overflow drain.
- No faucet holes; requires wall- or counter-mount faucet.
- Fits standard 14" x 17" (356 x 432 mm) countertop cutout.

Material

- Vitreous china.

Installation

- Undermount.

Recommended Products/Accessories

- K-8998 P-Trap
- K-23726 Drain treatment
- K-23725 Cast iron cleaner

Included Components

- Additional Components:
- 1193643 Basin clamps



ADA

Codes/Standards











- ASME A112.19.2/CSA B45.1
- ADA
- ICC/ANSI A117.1

KOHLER® One-Year Limited Warranty

See website for detailed warranty information.

Available Colors/Finishes

Color tiles intended for reference only.

Color	Code	Description
	0	White
	HW1	Honed White
	96	Biscuit
	47	Almond
	NY	Dune
	95	Ice™ Grey
	G9	Sandbar
	33	Mexican Sand™
	K4	Cashmere
	58	Thunder™ Grey
	7	Black Black™



Verticyl® Oval

Under-mount Bathroom Sink

K-2881

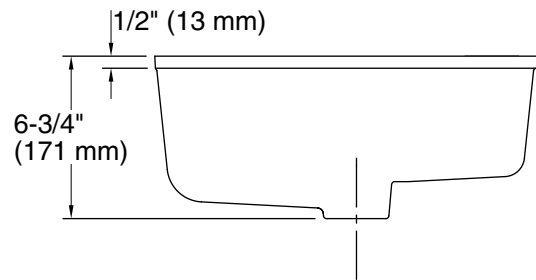
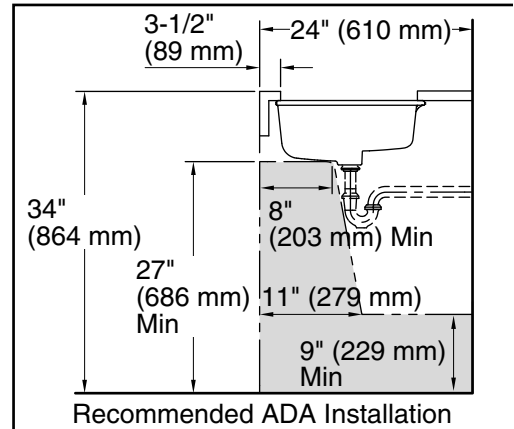
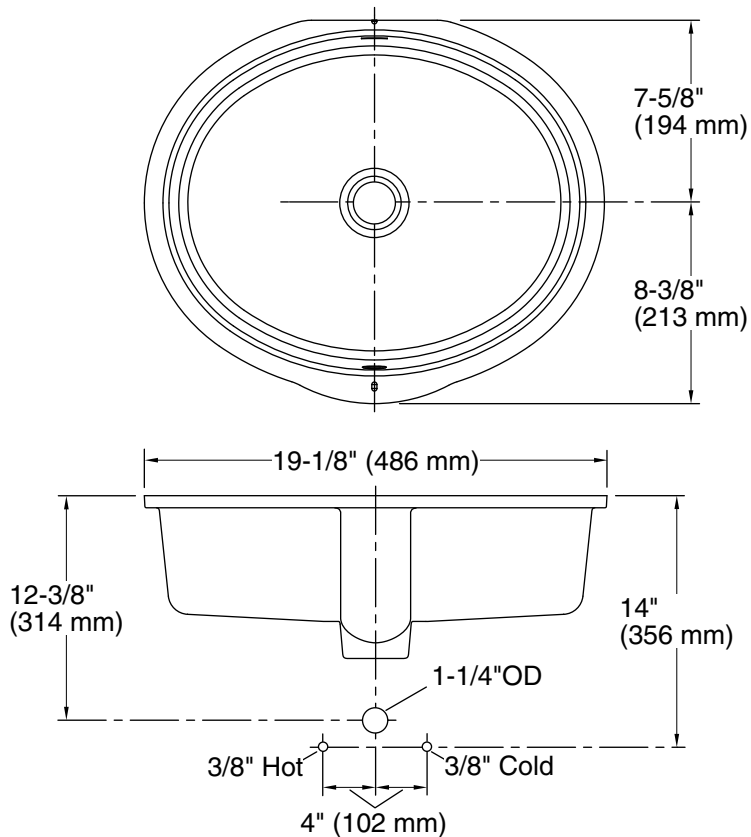

Technical Information

All product dimensions are nominal.

- Bowl configuration: Single
Installation: Under-mount
Bowl area (Only): Length: 17" (432 mm)
Width: 14" (356 mm)
Water depth: 3-1/8" (79 mm)
Drain hole: 1-3/4" (44 mm)
Template: 1151011-7, required, not included

Notes

Install this product according to the installation instructions.

NOTICE: Countertop manufacturer or cutter must use the current product template available at www.kohler.com, or by calling 1-800-4KOHLER. Kohler Co. is not responsible for cutout errors when the incorrect cutout template is used.

ADA compliant when installed to the specific requirements of these regulations.